

SPECIFICATION

Main Internal Antenna

Part No. : AMMAP003

	Designed	Checked		Approved
Date	/	/	/	/

Revision no	Content	Page	Date	Name
0	First, documented	-	2009.07.31	I.J. Jeong
1	Updated specification – 1.4 Marking	2	2010.04.26	I.J. Jeong

	AMOTECH CO., LTD 5B-1L, 617, NAMCHON-DONG, NAMDONG-GU, INCHOEN-CITY, KOREA TEL : 82-32-821-0363 FAX : 82-32-811-0283	Designed	Checked		Approved

Notes

The contents of this data sheet are subject to change without notice. Please confirm the specifications and delivery conditions when placing your order.

1. SPECIFICATIONS

1.1. Electrical Specifications

ITEM	GSM850	GSM900	DCS	PCS	UMTS	Remark
Frequency [MHz]	824~894	880~960	1710~1880	1850~1990	1920~2170	Notes :1)
Peak Gain [dBi]	1.3	2.4	6.4	5.9	4.8	Notes :1)
Eff.[%] @Min	42.4%	57.3%	80.7%	84.0%	82.1%	Notes :1)
VSWR	3.0 : 1 max					Notes :1)
	3.5:1 Max @725~855MHz		3.0:1 Max @1510~2070MHz			Notes :2)
Polarization	Linear					Notes :1)
Azimuth Beam Pattern	Omni-directional					Notes :1)
Impedance	50 Ω					Notes :1)

※Notes:1) Measured on the matched EV test board.

Notes:2) Measured on the matched AMOTECH manual jig.

1.2. Mechanical Specifications

Electrode	Silver	-
Dimensions (L x W x H)	24.0 x 5.5 x 4.4	mm
Operating Temperature	-35 ~ +85	°C

1.3. Appearance and Dimensions

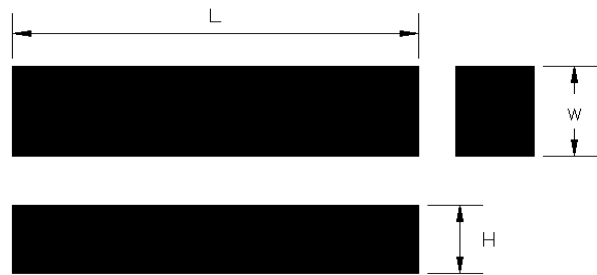
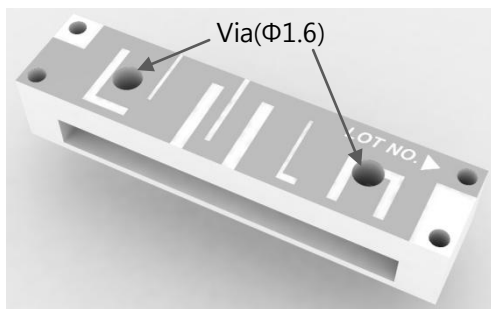

Unit : mm
Tolerance : ±0.15

1.4 Marking

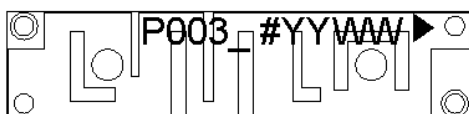

- P003** : Model No.
YY : Year (ex: 2010 → 10)
WW : Week (ex: 1st week→01, 7th week→07)
▶ : Feeding point

2. MEASUREMENT

2.1. SET for Measurement

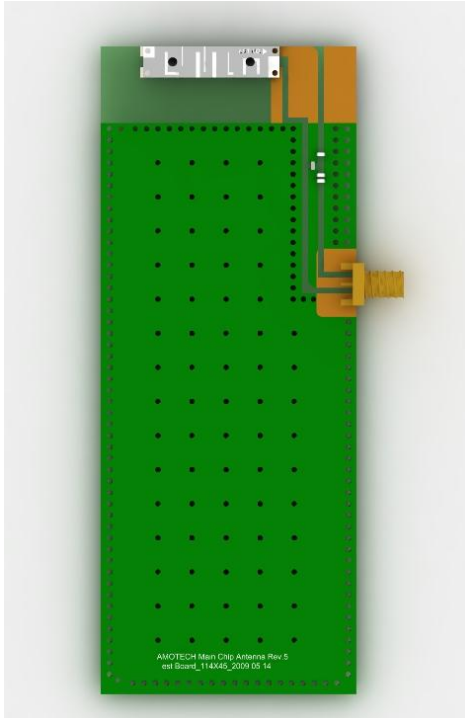

Board size: 114x45mm

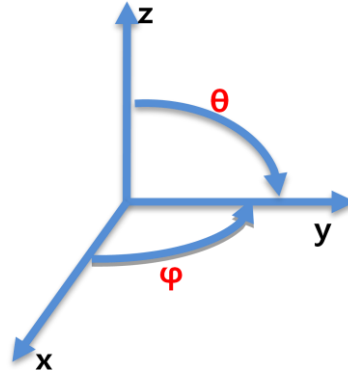

Antenna Radiation coordinate system

2.2. Electrical Characteristic

◆ S_{11} (VSWR)

Penta Band (GSM850&900, DCS, PCS, UMTS)

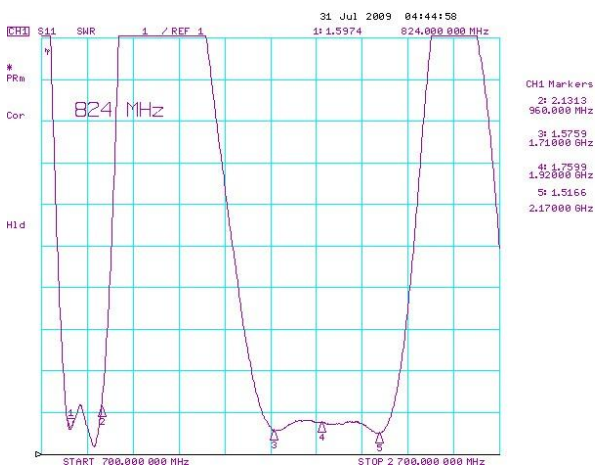

- VSWR @ EV Board -

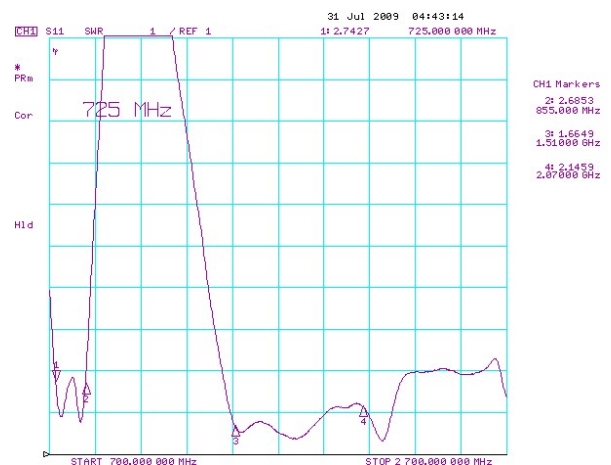

- VSWR @ Manual Jig -

2.3. Radiation Characteristic

- Measurement Setup

- 6mx3mx3m Anechoic Chamber
- Matching on the standard test board (114 x 45mm)
- Temp. : 25°C / Humidity : 50~55%

- Measurement Result

Band	Frequency MHz]	Ave. gain (dBi)	Peak. Gain (dBi)	Eff.(%)
GSM850	824	-3.7	-0.3	42.4
	849	-3.6	-0.2	43.8
	869	-3.3	0.4	47.1
	894	-2.5	1.3	56.1
GSM900	880	-2.4	1.5	57.3
	915	-1.9	2.2	64.6
	925	-1.8	2.4	65.8
	960	-2.3	1.8	58.2
DCS	1710	-0.4	6.4	90.9
	1785	-0.9	5.8	80.7
	1805	-0.6	6.1	86.2
	1880	-1.1	5.4	76.8
PCS	1850	-0.8	5.6	84.0
	1910	-0.5	5.9	89.8
	1930	-0.5	5.8	88.6
	1990	-0.6	5.5	86.7
UMTS	1920	-0.7	4.8	84.9
	1980	-0.9	4.5	82.1
	2110	-0.5	4.6	89.5
	2170	-0.2	4.5	95.4

3. SOLDERING RECOMMENDATIONS

3.1. Soldering Land Pattern

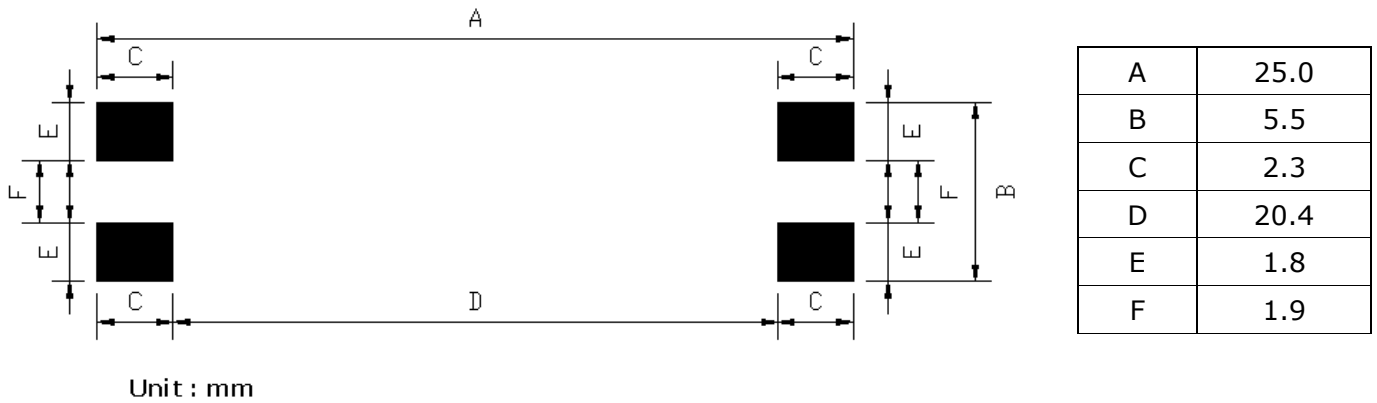

3.2. Free Space Size

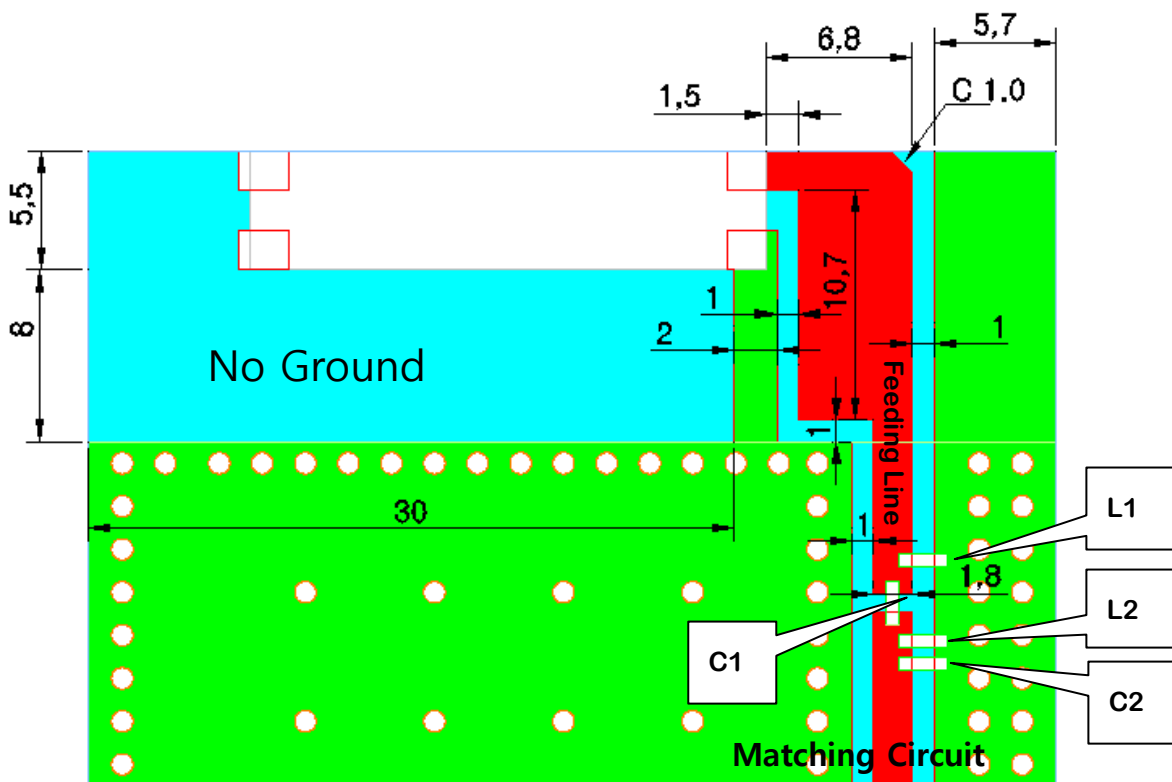

C1 (Series)	3.6pF
C2 (Shunt)	1.8pF
L1 (Shunt)	3.9nH
L2 (Shunt)	2.7nH

3.2. Soldering Profile

Solder paste : Sn/Ag/Cu:96.5/3.0/0.5

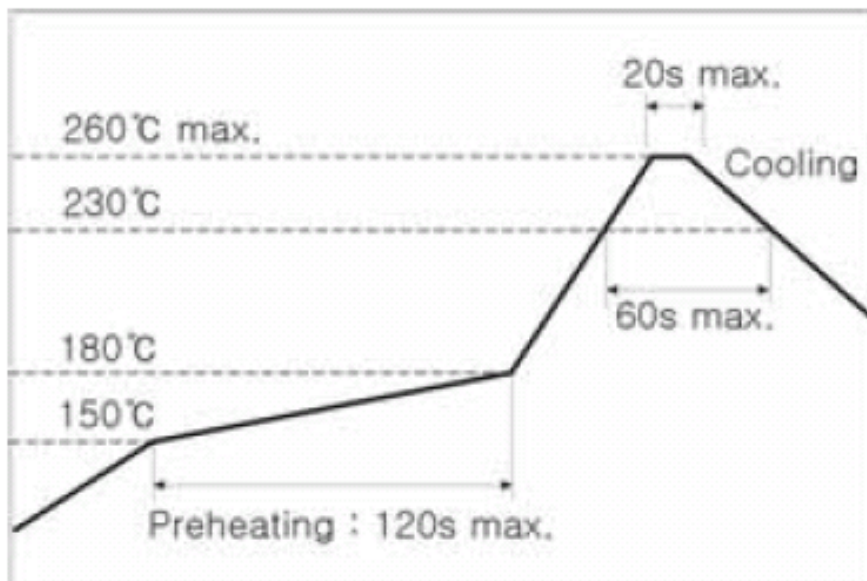

This product is designed for reflow soldering only. Do not use flow (wave) soldering.

- ① Use non-activated flux (Cl content 0.2% max.)
- ② Follow the recommended soldering conditions to avoid damage.
- ③ Reflow-cycle is max. 3 times.

4. ATTACHMENT

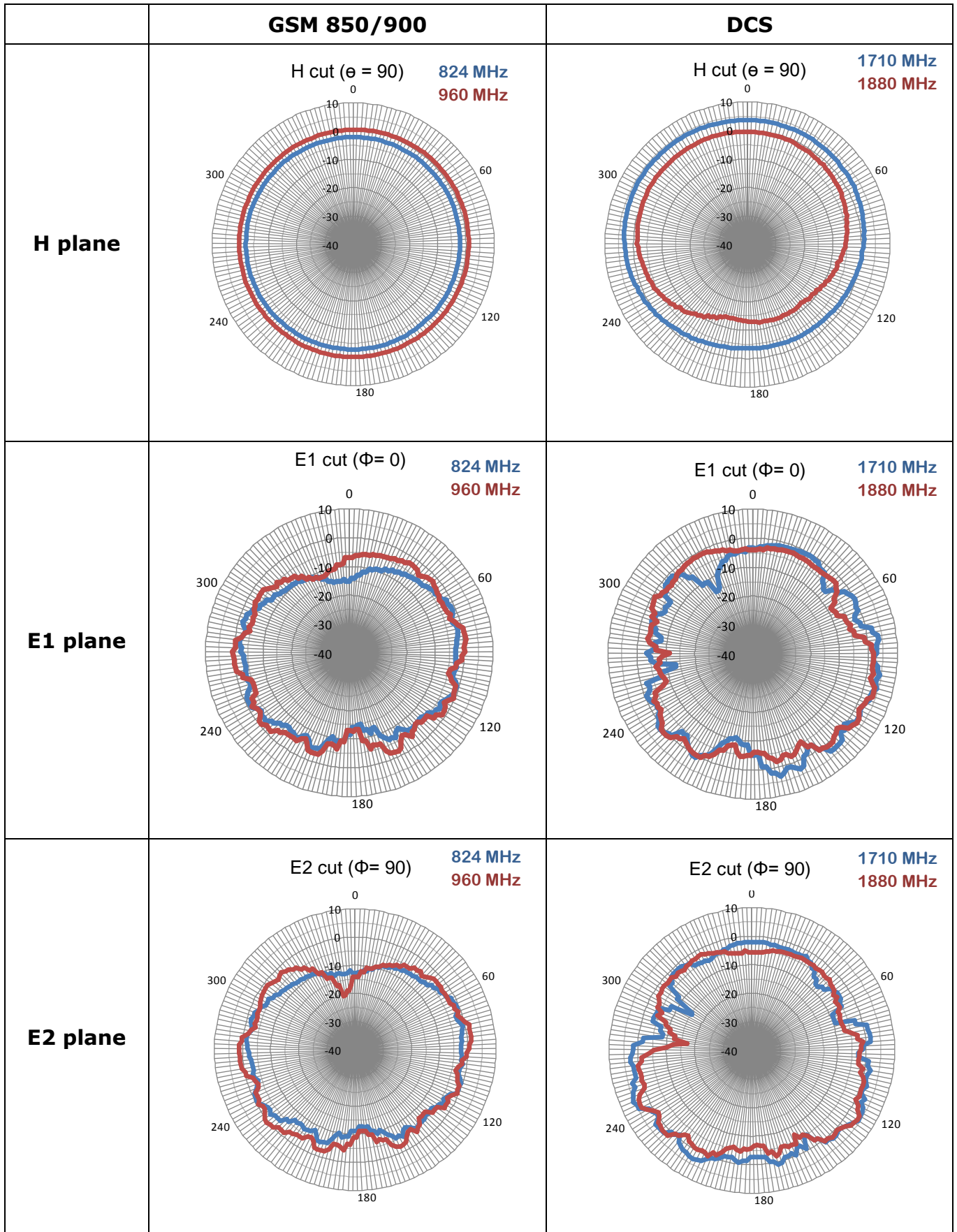

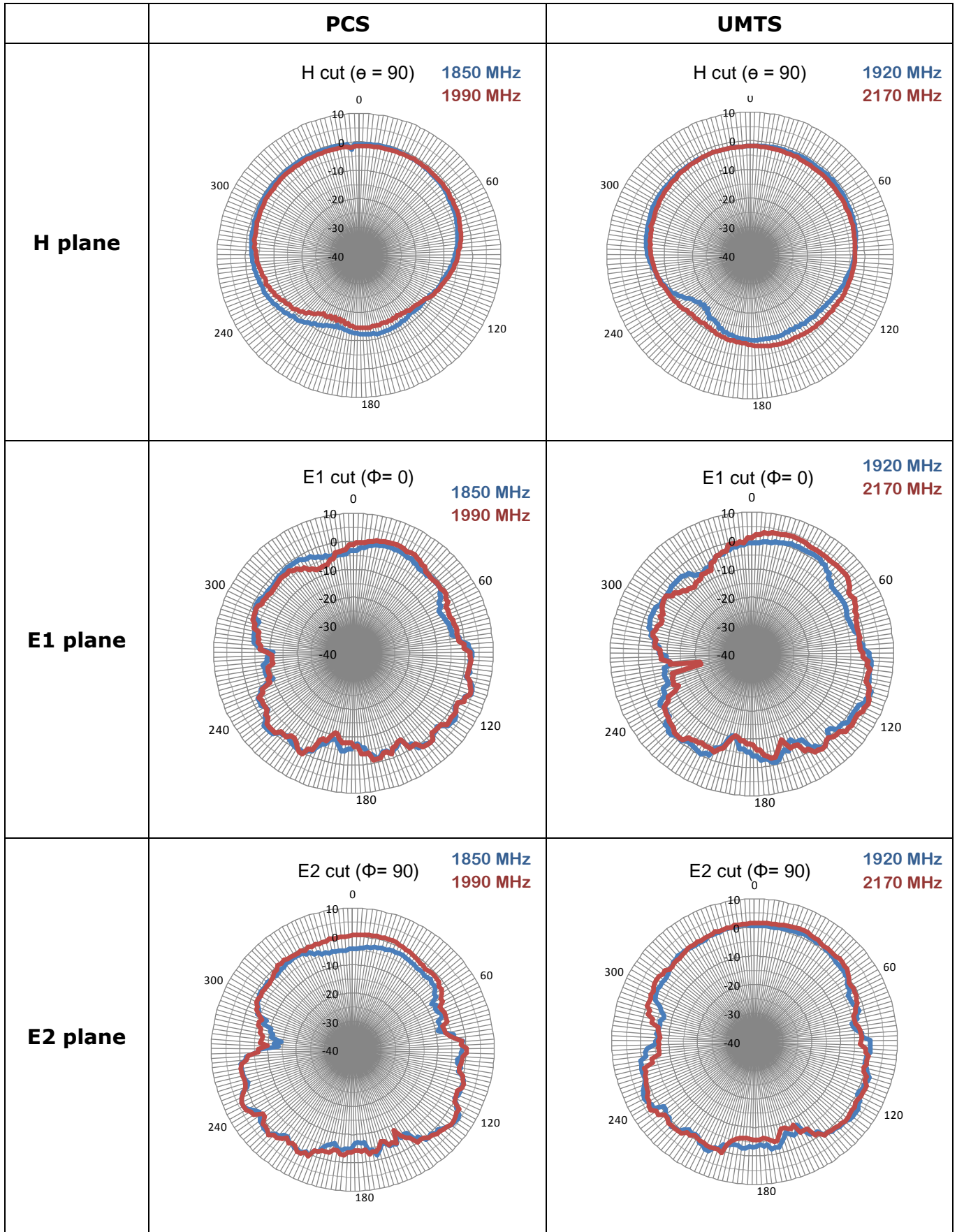

5. PACKING

5.1 Tape Dimension (unit : mm)

5.1.1 Size

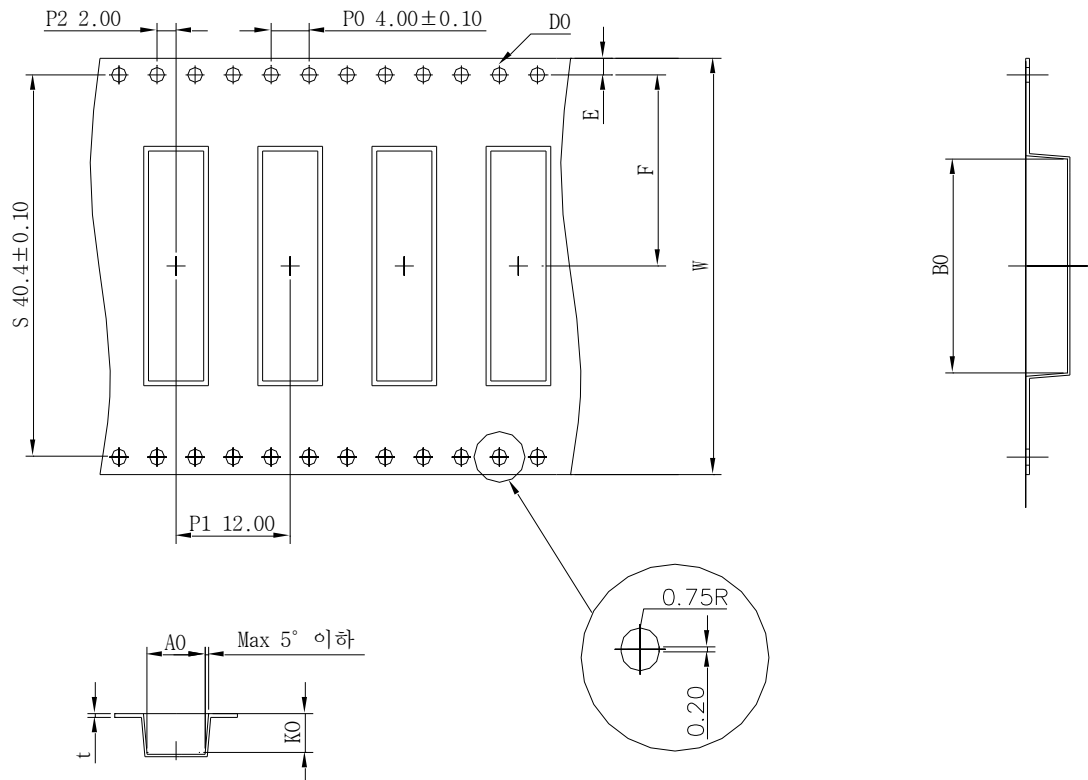

A0	5.80±0.20	E	1.75±0.10
B0	24.30±0.20	F	20.20±0.20
K0	4.60±0.20	W	44.00±0.30
D0	1.55±0.05	t	0.40±0.05

5.1.2 Surface resistance

- 1) Carrier tape : Max $10^{11}\Omega$
- 2) Cover tape : Max $10^{11}\Omega$
- 3) Reel : Max $10^{11}\Omega$

5.2 Description of Reel

5.2.1 Size

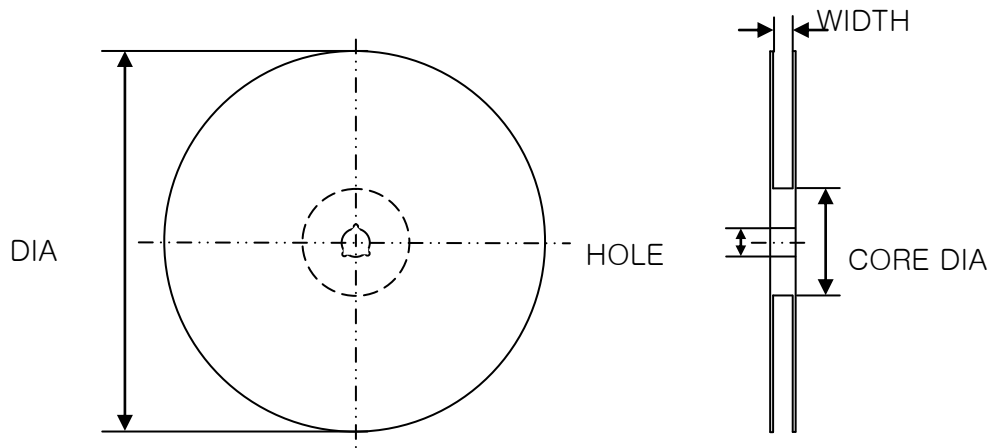

ITEM	DIA	WIDTH	CORE DIA	HOLE
Size(mm)	330.0 ±2	45.5 ± 0.5	100.0 ± 1	13.0 ± 0.3

5.2.2 Material

- 1) Plastic reel : GPPS (General Purpose Poly Styrene) resin

5.3 Description of Packing Box

5.3.1 Reel

Size : 44 (W), Dia.Φ330 (mm)

Quantity : 1,000 ea/reel

5.3.2 Inner Box

Size : 350 (W) x 345 (D) x 55 (T) (mm)

Quantity : 1 reel (1,000 ea/reel × 1 reel = 1,000 ea)



5.3.3 Outer Box

Size : 405 (W) x 360 (D) x 300 (T) (mm)

Quantity : 5 Inner Box (1,000 ea/Inner Box × 5 Inner Box=5,000 ea)

