

## C3535W-W6H-3WY

3.5x3.5mm,Warm White LED

Ceramic Package Top View LED Light Sourcer



### Technical Data Sheet

---

#### Features:

- Small SMT ceramic package with high efficiency.
- Low thermal resistance.
- Soldering method: SMT.
- Binning Parameters: Brightness, Forward.
- Voltage, Wavelength and Chromaticity.
- Matches ANSI binning.
- Reflow soldering with JEDEC JSTD-020C compatible.
- The product itself will remain within RoHS compliant Version.

#### Descriptions:

- The C3535 series is a surface-mount high-power device featuring high brightness combined with a compact size that is suitable for all kinds of lighting applications such as general illumination, flash, spot, signal, industrial and commercial lighting. The thermal pad of this device is electrically isolated providing convenience in thermal and electrical design.
- The C3535 series is one of the most promising devices in LuckyLight's high power product offering and is ready to face the challenges of today's Solid-State Lighting requirements.

#### Applications:

- General Lighting.
- General luminaire.
- Decorative and Entertainment Lighting.
- Exterior and Interior Automotive.
- Agriculture Lighting.
- Bulb.
- Downlight.

# C3535W-W6H-3WY

3.5x3.5mm, Warm White LED

Ceramic Package Top View LED Light Sourcer



## Technical Data Sheet

Part No.	Emitting Color
C3535W-W6H-3WY	Warm White

### Package Dimension:

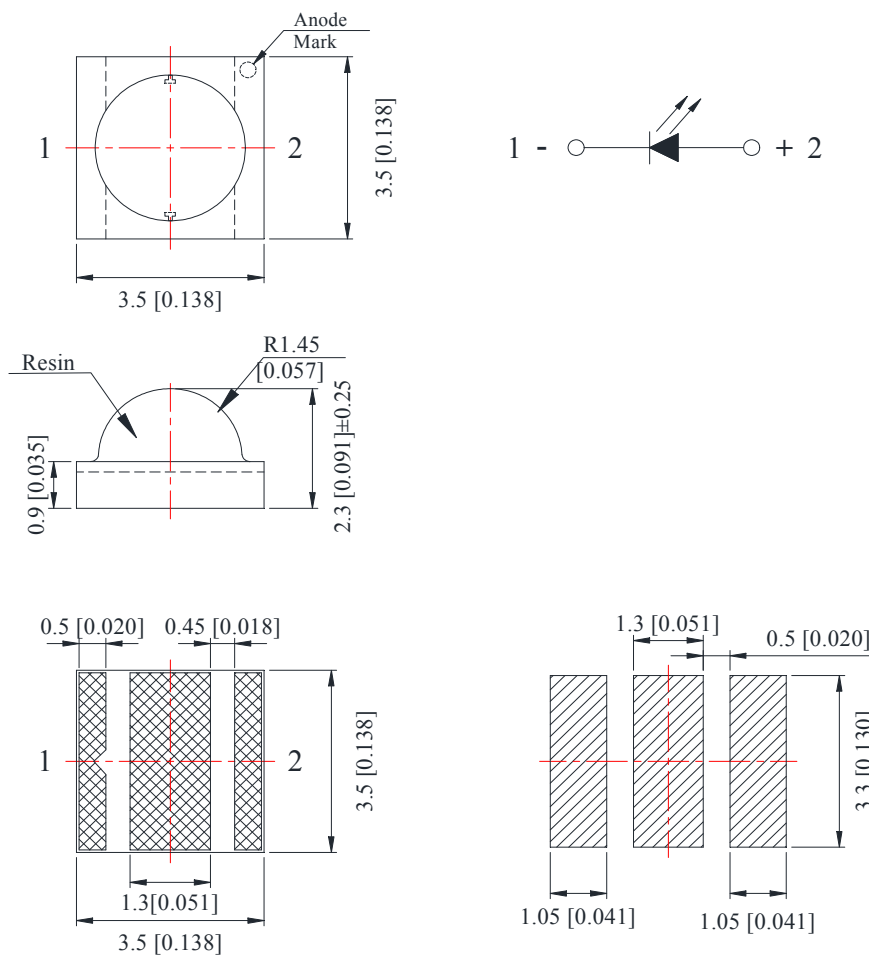

### Notes:

1. All dimensions are in millimeters (inches).
2. Tolerance is ± 0.25 mm (.010") unless otherwise noted.

# C3535W-W6H-3WY

3.5x3.5mm,Warm White LED

Ceramic Package Top View LED Light Sourcer

## Technical Data Sheet

### Absolute Maximum Ratings at Ta=25°C

Parameters	Symbol	Max	Unit
Power Dissipation	Pd	1~3	W
Peak Forward Current <sup>(a)</sup>	IFP	1000	mA
DC Forward Current	IF	700	mA
Reverse Voltage	VR	5	V
Electrostatic Discharge (HBM)	ESD	1000	V
LED Junction Temperature	Tj	120	°C
Operating Temperature Range	Topr	-40°C to +85°C	
Storage Temperature Range	Tstg	-40°C to +85°C	
Soldering Temperature	Tsld	260°C for 5 Seconds	

Note:

a.Pulse width≤0.1ms, Duty≤1/10

### Electrical Optical Characteristics at Ta=25°C

Parameters	Symbol	Min.	Typ.	Max.	Unit	Test Condition
Luminous Flux <sup>(a)</sup>	Φv	100	130	---	Lm	IF=350mA
		240	270	---	Lm	IF=700mA
Viewing Angle	2θ1/2	---	120	---	Deg	IF=350mA
Chromaticity Coordinates <sup>(b)</sup>	x	---	0.43	---		IF=350mA
	y	---	0.40	---		
Color Temperature	CCT	2800	3000	---	K	IF=350mA
Color Rendering Index	CRI	70	---	---	Ra	IF=350mA
Forward Voltage <sup>(c)</sup>	VF	2.80	3.20	3.60	V	IF=350mA
Reverse Current	IR	---	---	10	μA	VR=5V

Notes:

- a. Luminous flux measurement tolerance: ±10%.
- b. Color coordinates measurement tolerance: ±0.015
- c. Forward voltage measurement tolerance: ±0.1V

# C3535W-W6H-3WY

3.5x3.5mm, Warm White LED

Ceramic Package Top View LED Light Sourcer



## Technical Data Sheet

### Typical Electrical / Optical Characteristics Curves (25°C Ambient Temperature Unless Otherwise Noted)

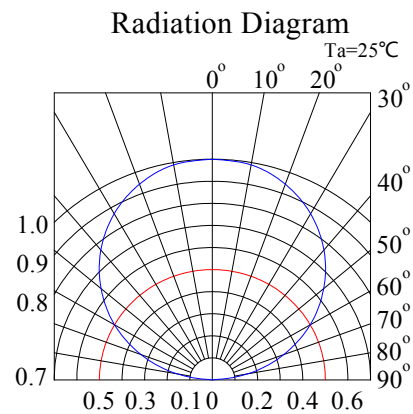
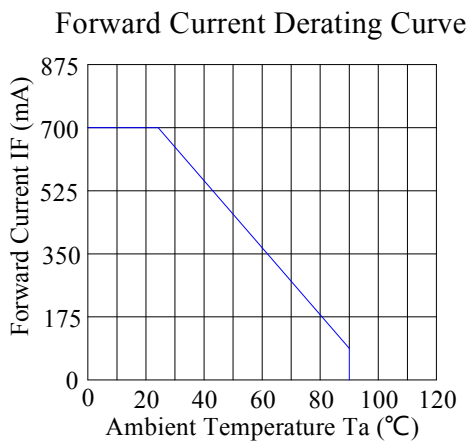
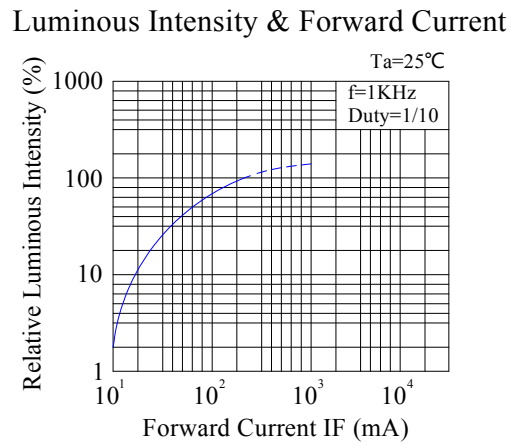
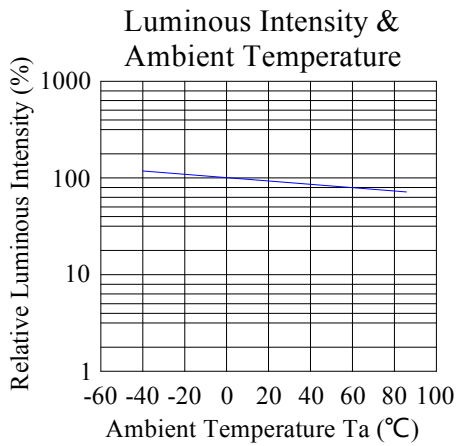
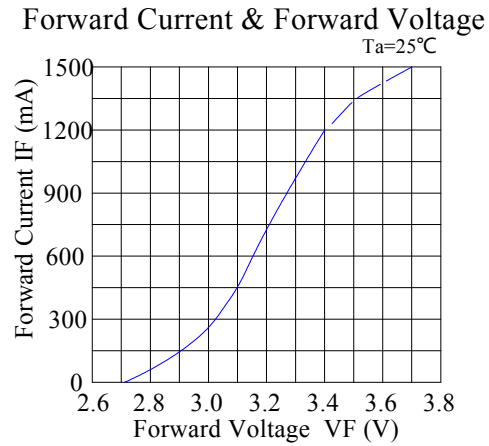
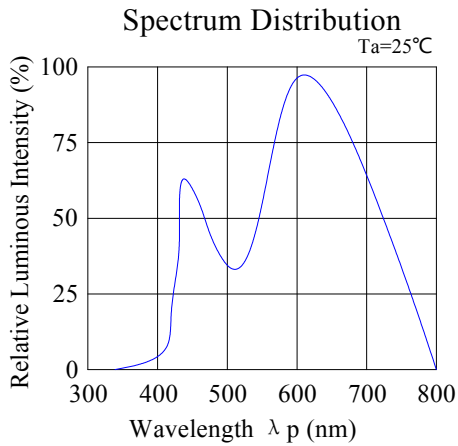

# C3535W-W6H-3WY

3.5x3.5mm,Warm White LED

Ceramic Package Top View LED Light Sourcer



## Technical Data Sheet

### CIE 1931 Chromaticity Diagram:

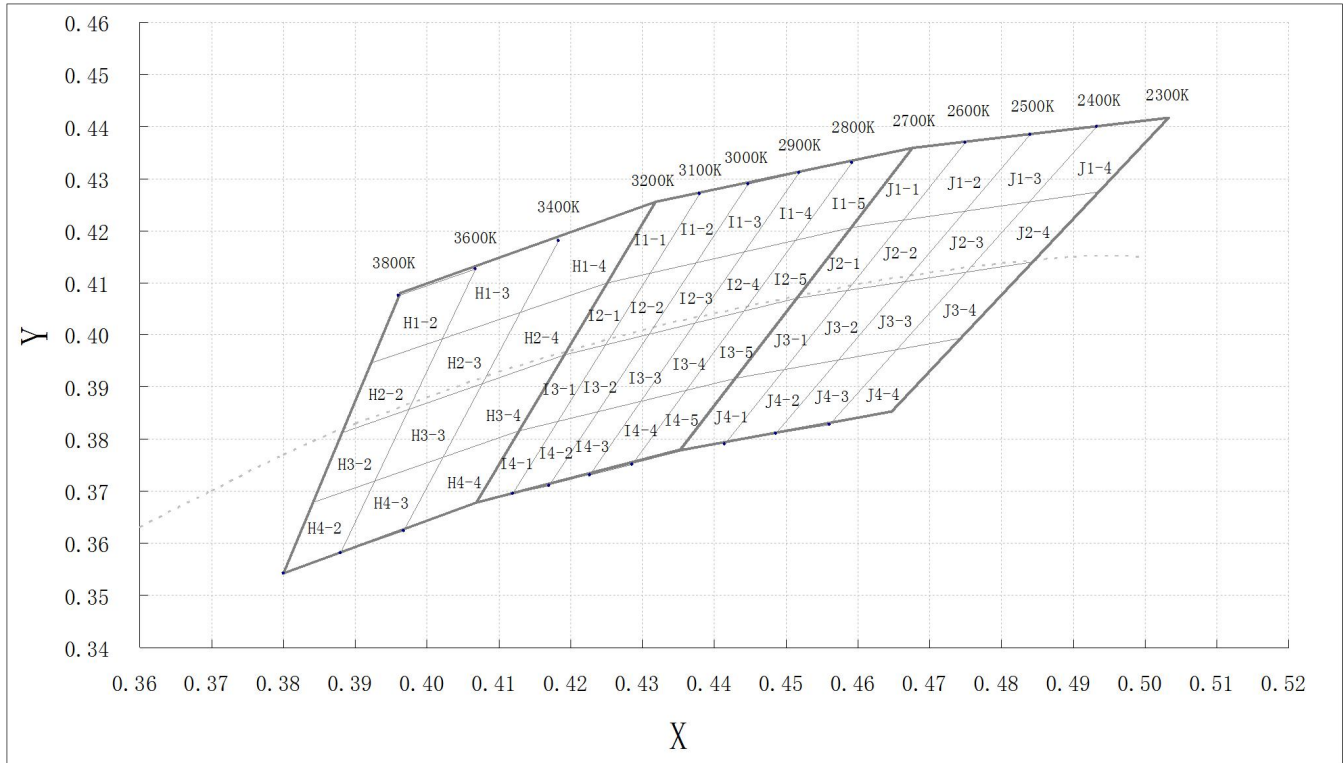

### Chromaticity Coordinates Specifications for Bin Rank:

Bin Code	Left x	Left y	Top x	Top y	Right x	Right y	Bottom x	Bottom y
H1-2	0.392	0.394	0.402	0.399	0.407	0.413	0.396	0.408
H2-2	0.388	0.381	0.397	0.386	0.402	0.399	0.392	0.394
H3-2	0.384	0.367	0.393	0.372	0.397	0.386	0.388	0.381
H4-2	0.380	0.354	0.388	0.358	0.393	0.372	0.384	0.367
H1-3	0.402	0.399	0.412	0.403	0.418	0.419	0.407	0.413
H2-3	0.397	0.386	0.407	0.390	0.412	0.403	0.402	0.399
H3-3	0.393	0.372	0.402	0.376	0.407	0.390	0.397	0.386
H4-3	0.388	0.358	0.397	0.362	0.402	0.376	0.393	0.372
H1-4	0.412	0.403	0.425	0.410	0.432	0.426	0.418	0.419
H2-4	0.407	0.390	0.419	0.396	0.425	0.410	0.412	0.403
H3-4	0.402	0.376	0.413	0.382	0.419	0.396	0.407	0.390
H4-4	0.397	0.362	0.407	0.368	0.413	0.382	0.402	0.376
I1-1	0.425	0.410	0.431	0.412	0.438	0.428	0.432	0.426
I2-1	0.419	0.396	0.424	0.398	0.431	0.412	0.425	0.410
I3-1	0.413	0.382	0.418	0.384	0.424	0.398	0.419	0.396
I4-1	0.407	0.368	0.412	0.370	0.418	0.384	0.413	0.382

Spec No.: C3535

Issue No.: G-Rev-4

LuckyLight Electronics Co., Ltd

Copyright © 2022 LuckyLight All Rights Reserved

Date: 12-Sep-2022

E-mail: sales@luckylight.cn

http:// www.luckylight.cn

Page: 5 / 13

# C3535W-W6H-3WY

3.5x3.5mm,Warm White LED

Ceramic Package Top View LED Light Sourcer



## Technical Data Sheet

I1-2	0.431	0.412	0.437	0.414	0.445	0.430	0.438	0.428
I2-2	0.424	0.398	0.430	0.400	0.437	0.414	0.431	0.412
I3-2	0.418	0.384	0.423	0.385	0.430	0.400	0.424	0.398
I4-2	0.412	0.370	0.417	0.372	0.423	0.385	0.418	0.384
I1-3	0.437	0.414	0.444	0.416	0.452	0.432	0.445	0.430
I2-3	0.430	0.400	0.437	0.402	0.444	0.416	0.437	0.414
I3-3	0.423	0.385	0.430	0.387	0.437	0.402	0.430	0.400
I4-3	0.417	0.372	0.423	0.374	0.430	0.387	0.423	0.385
I1-4	0.444	0.416	0.451	0.418	0.459	0.434	0.452	0.432
I2-4	0.437	0.402	0.444	0.404	0.451	0.418	0.444	0.416
I3-4	0.430	0.387	0.436	0.389	0.444	0.404	0.437	0.402
I4-4	0.423	0.374	0.429	0.376	0.436	0.389	0.430	0.387
I1-5	0.451	0.418	0.460	0.421	0.468	0.436	0.459	0.434
I2-5	0.444	0.404	0.452	0.407	0.460	0.421	0.451	0.418
I3-5	0.436	0.389	0.444	0.392	0.452	0.407	0.444	0.404
I4-5	0.429	0.376	0.436	0.378	0.444	0.392	0.436	0.389
J1-1	0.460	0.421	0.466	0.422	0.475	0.437	0.468	0.436
J2-1	0.452	0.407	0.458	0.408	0.466	0.422	0.460	0.421
J3-1	0.444	0.392	0.449	0.393	0.458	0.408	0.452	0.407
J4-1	0.436	0.378	0.441	0.379	0.449	0.393	0.444	0.392
J1-2	0.466	0.422	0.475	0.424	0.484	0.439	0.475	0.437
J2-2	0.458	0.408	0.467	0.410	0.475	0.424	0.466	0.422
J3-2	0.449	0.393	0.458	0.395	0.467	0.410	0.458	0.408
J4-2	0.441	0.379	0.449	0.381	0.458	0.395	0.449	0.393
J1-3	0.475	0.424	0.483	0.425	0.493	0.440	0.484	0.439
J2-3	0.467	0.410	0.475	0.412	0.483	0.425	0.475	0.424
J3-3	0.458	0.395	0.465	0.397	0.475	0.412	0.467	0.410
J4-3	0.449	0.381	0.456	0.383	0.465	0.397	0.458	0.395
J1-4	0.483	0.425	0.493	0.427	0.503	0.442	0.493	0.440
J2-4	0.475	0.412	0.484	0.414	0.493	0.427	0.483	0.425
J3-4	0.465	0.397	0.474	0.399	0.484	0.414	0.475	0.412
J4-4	0.456	0.383	0.465	0.385	0.474	0.399	0.465	0.397

### Notes:

1. Color coordinates measurement allowance is  $\pm 0.015$ .
2. One delivery will include up to two consecutive color ranks and three luminous intensity ranks of the products the quantity-ratio of the ranks is decided by **LuckyLight**.

Spec No.: C3535

Issue No.: G-Rev-4

LuckyLight Electronics Co., Ltd

Copyright © 2022 LuckyLight All Rights Reserved

Date: 12-Sep-2022

E-mail: sales@luckylight.cn

http:// www.luckylight.cn

Page: 6 / 13

# C3535W-W6H-3WY

3.5x3.5mm,Warm White LED

Ceramic Package Top View LED Light Sourcer



## Technical Data Sheet

### CIE Chromaticity Diagram:

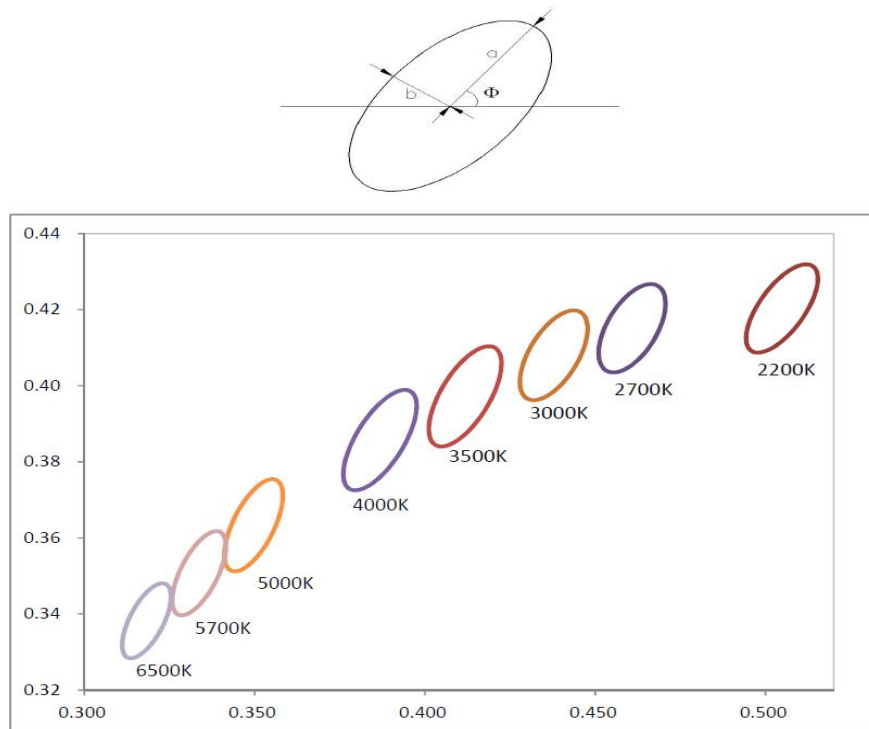

The color ranks have chromaticity ranges within 5-step MacAdam ellipse:

Color Rendering	Color Code	Center		Radius		Angle (deg)
		x	y	a	b	Φ
70	2200	0.5047	0.4182	0.014350	0.006300	49.16
	2700	0.4607	0.4130	0.013500	0.007000	53.42
	3000	0.4367	0.4059	0.013835	0.006835	53.13
	3500	0.4102	0.3951	0.015500	0.006835	54.00
	4000	0.3847	0.3836	0.015665	0.006665	53.43
	5000	0.3476	0.3592	0.013665	0.005850	59.37
	5700	0.3316	0.3456	0.01250	0.005335	59.05
	6500	0.3152	0.3321	0.011165	0.004835	58.34

Notes:

- \* Energy Star binning applied to all 2200~7000K.
- \* Tolerance of measurements of the chromaticity Coordinate is  $\pm 0.005$

# C3535W-W6H-3WY

3.5x3.5mm, Warm White LED

Ceramic Package Top View LED Light Sourcer



## Technical Data Sheet

### Reel Dimensions:

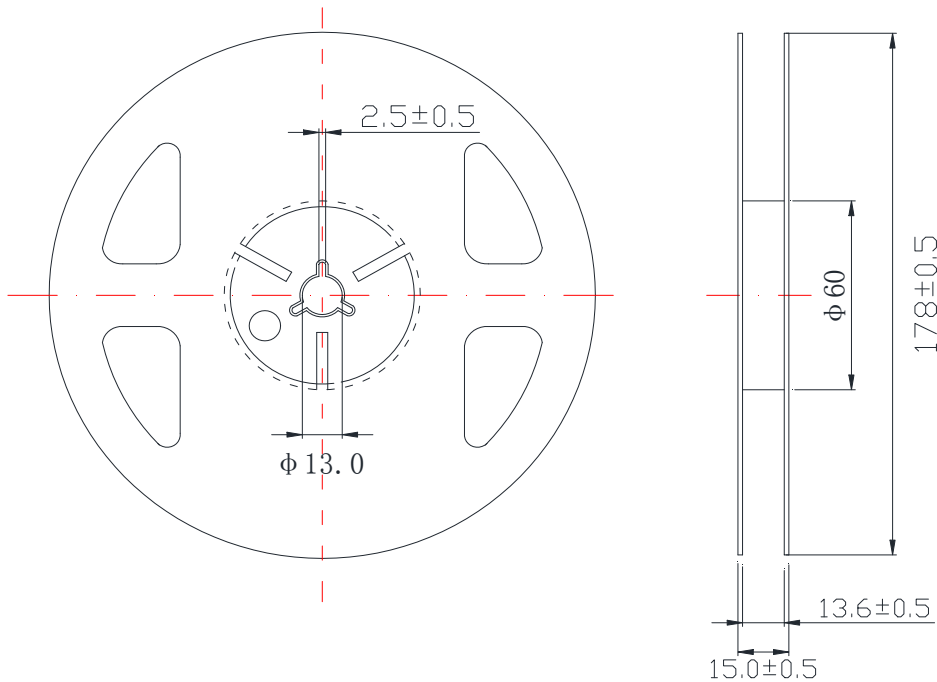

### Carrier Tape Dimensions:

Loaded quantity 1000 pcs per reel.

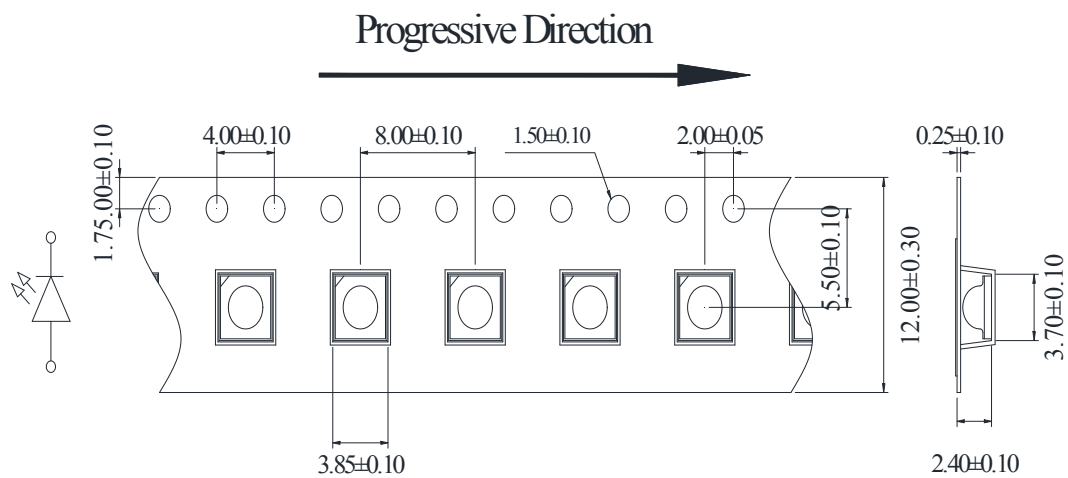

# C3535W-W6H-3WY

3.5x3.5mm, Warm White LED

Ceramic Package Top View LED Light Sourcer



## Technical Data Sheet

### Packing & Label Specifications:

Moisture Resistant Packaging:

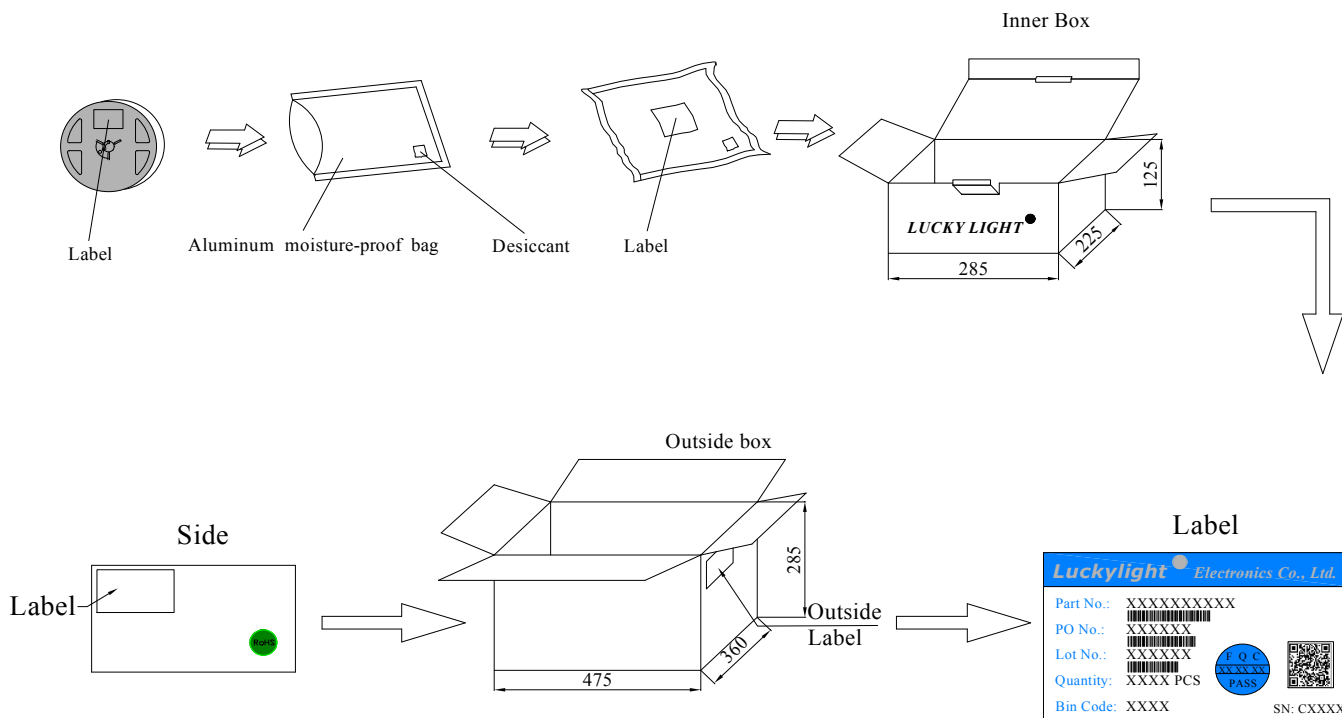

Spec No.: C3535

Issue No.: G-Rev-4

LuckyLight Electronics Co., Ltd

Copyright © 2022 LuckyLight All Rights Reserved

Date: 12-Sep-2022

E-mail: sales@luckylight.cn

http:// www.luckylight.cn

Page: 9 / 13

**Technical Data Sheet**

---

**CAUTIONS****1. Handling Precautions:**

- 1.1. Handle the component along the side surfaces by using forceps or appropriate tools.
- 1.2. Do not directly touch or handle the silicone lens surface. It may damage the internal circuitry.
- 1.3. Do not stack together assembled PCBs containing exposed LEDs. Impact may scratch the silicone lens or damage the internal circuitry.

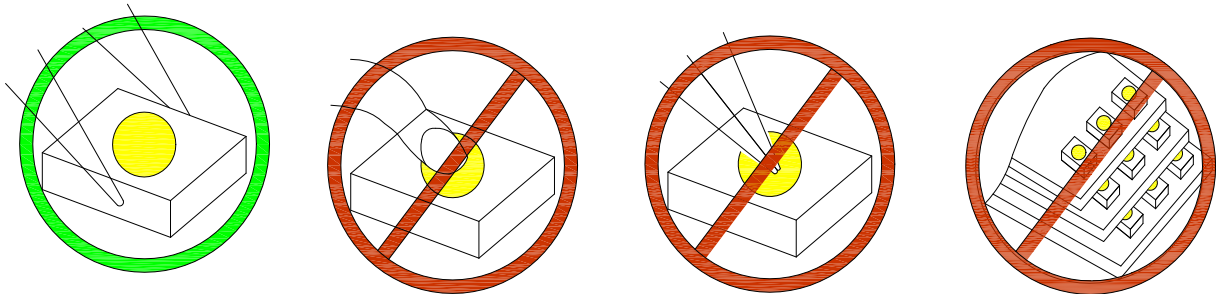

Compare to epoxy encapsulant that is hard and brittle, silicone is softer and flexible. Although its characteristic significantly reduces thermal stress, it is more susceptible to damage by external mechanical force. As a result, special handling precautions need to be observed during assembly using silicone encapsulated LED products. Failure to comply might lead to damage and premature failure of the LED.

**2. Storage**

- 2.1. Do not open moisture proof bag before the products are ready to use.
- 2.2. Before opening the package, the LEDs should be kept at 30°C or less and 60%RH or less.
- 2.3. The LEDs should be used within a year.
- 2.4. After opening the package, the LEDs should be kept at 30°C or less and 60%RH or less.
- 2.5. The LEDs should be used within 24 hours after opening the package.
- 2.6. If the moisture adsorbent material has fabled away or the LEDs have exceeded the storage time, baking treatment should be performed using the following conditions. Baking treatment: 65±5°C for 24 hours

**Technical Data Sheet**

**3. Soldering Condition**

**3.1. Pb-free solder temperature profile**

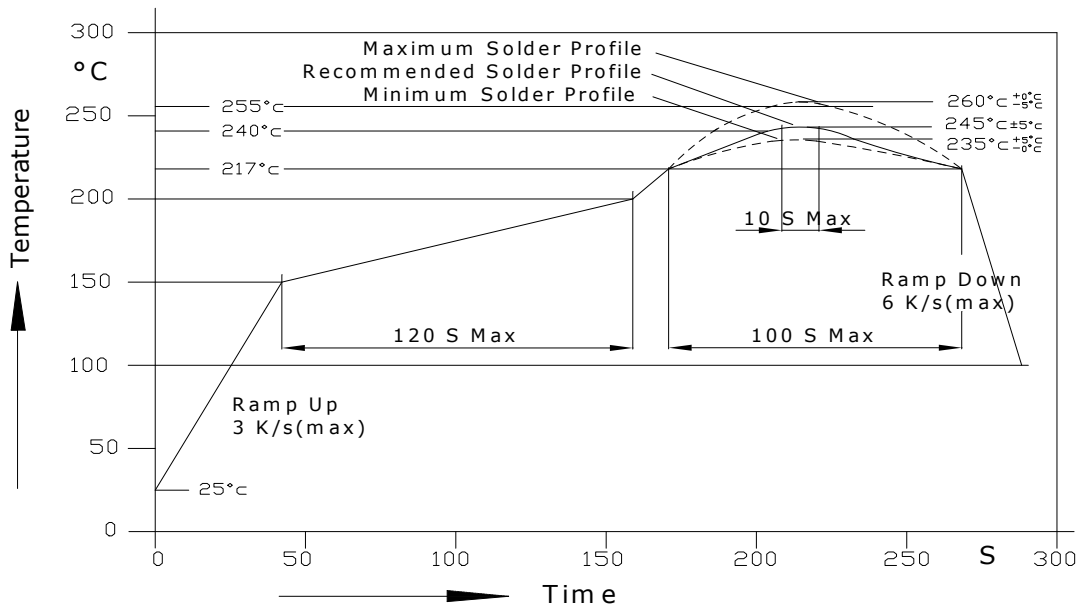

3.2. Reflow soldering should not be done more than two times.

3.3. When soldering, do not put stress on the LEDs during heating.

3.4. After soldering, do not warp the circuit board.

3.5. Recommended soldering conditions:

Reflow soldering		Soldering iron	
Pre-heat	150~200°C	Temperature	300°C Max.
Pre-heat time	120 sec. Max.	Soldering time	3 sec. Max.
Peak temperature	260°C Max.		(one time only)
Soldering time	10 sec. Max.(Max. two times)		

3.6. Because different board designs use different number and types of devices, solder pastes, reflow ovens, and circuit boards, no single temperature profile works for all possible combinations.

## Technical Data Sheet

---

However, you can successfully mount your packages to the PCB by following the proper guidelines and PCB-specific characterization.

### 4. Drive Method

4.1. An LED is a current-operated device. In order to ensure intensity uniformity on multiple LEDs connected in parallel in an application, it is recommended that a current limiting resistor be incorporated in the drive circuit, in series with each LED as shown in Circuit A below.

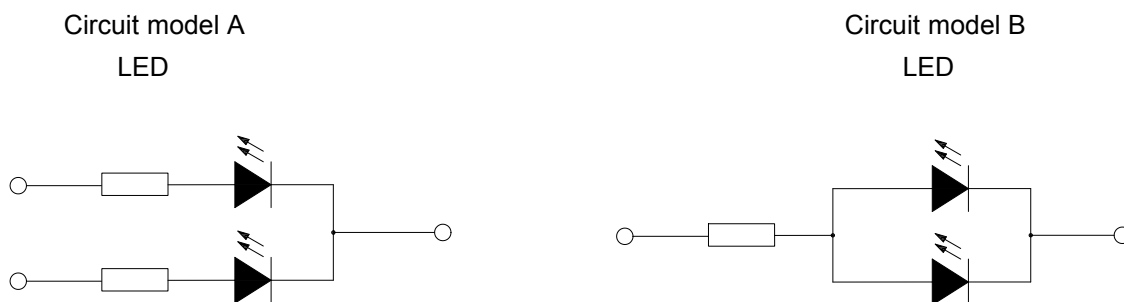

a. Recommended circuit.

b. The brightness of each LED might appear different due to the differences in the I-V characteristics of those LEDs.

### 5. ESD (Electrostatic Discharge):

Static Electricity or power surge will damage the LED. Suggestions to prevent ESD damage:

- Use of a conductive wrist band or anti-electrostatic glove when handling these LEDs.
- All devices, equipment, and machinery must be properly grounded.
- Work tables, storage racks, etc. should be properly grounded.
- Use ion blower to neutralize the static charge which might have built up on surface of the LED's plastic lens as a result of friction between LEDs during storage and handling.

ESD-damaged LEDs will exhibit abnormal characteristics such as high reverse leakage current, low forward voltage, or “no lightup” at low currents. To verify for ESD damage, check for “lightup” and  $V_f$  of the suspect LEDs at low currents. The  $V_f$  of “good” LEDs should be  $>2.0V@0.1mA$  for InGaN product and  $>1.4V@0.1mA$  for AlInGaP product.

## C3535W-W6H-3WY

3.5x3.5mm,Warm White LED

Ceramic Package Top View LED Light Sourcer



### Technical Data Sheet

---

#### Terms and conditions for the usage of this document

1. The information included in this document reflects representative usage scenarios and is intended for technical reference only.
2. The part number, type, and specifications mentioned in this document are subject to future change and improvement without notice. Before production usage customer should refer to the latest datasheet for the updated specifications.
3. When using the products referenced in this document, please make sure the product is being operated within the environmental and electrical limits specified in the datasheet. If customer usage exceeds the specified limits, LuckyLight will not be responsible for any subsequent issues.
4. The information in this document applies to typical usage in consumer electronics applications. If customer's application has special reliability requirements or have life-threatening liabilities, such as automotive or medical usage, please consult with LuckyLight representative for further assistance.
5. The contents and information of this document may not be reproduced or re-transmitted without permission by LuckyLight.